

Drawings / Zeichnungen:
ArciTech

Technik für Möbel

Hettich

Model / Ausführung	Drawer / Schubkasten
Profile height / Zargenhöhe	126 mm
Nominal length / Nennlänge	500 mm
Cabinet side panel thickness / Korpuseitendicke	16 / 18 / 19 mm

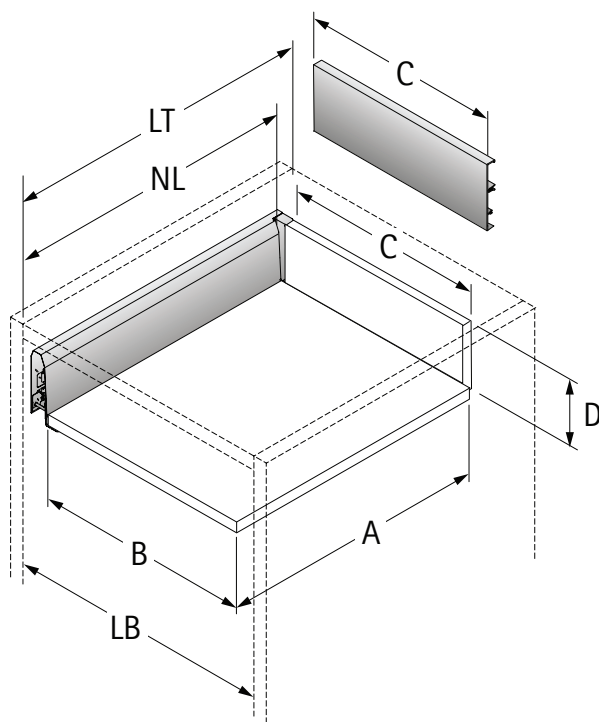

Measurement / Maß	Steel rear panel / Stahlrückwand	Wooden rear panel / Holzrückwand	Aluminium rear panel / Aluminiumrückwand
A	479	475,5	475,5
B	LB – 2x EB – 52	LB – 2x EB – 52	LB – 2x EB – 52
C	-	LB – 2x EB – 63,5	LB – 2x EB – 63,5
D	-	116,5	-

Note: For Push to open applications the minimum cabinet depth increases by 12 mm.

Achtung: Bei der Verwendung von Push to open erhöht sich die Mindestkorpustiefe um 12 mm.

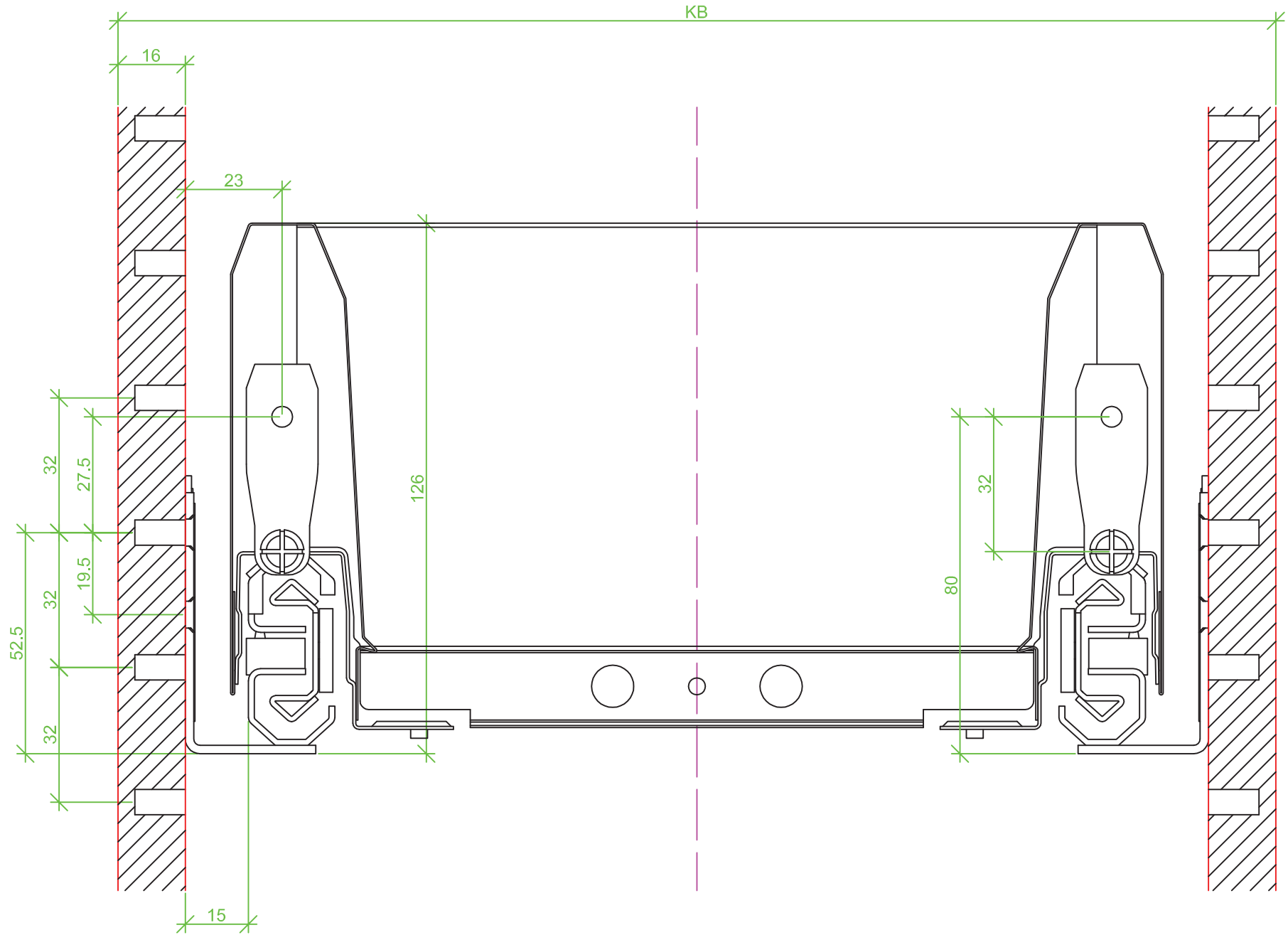

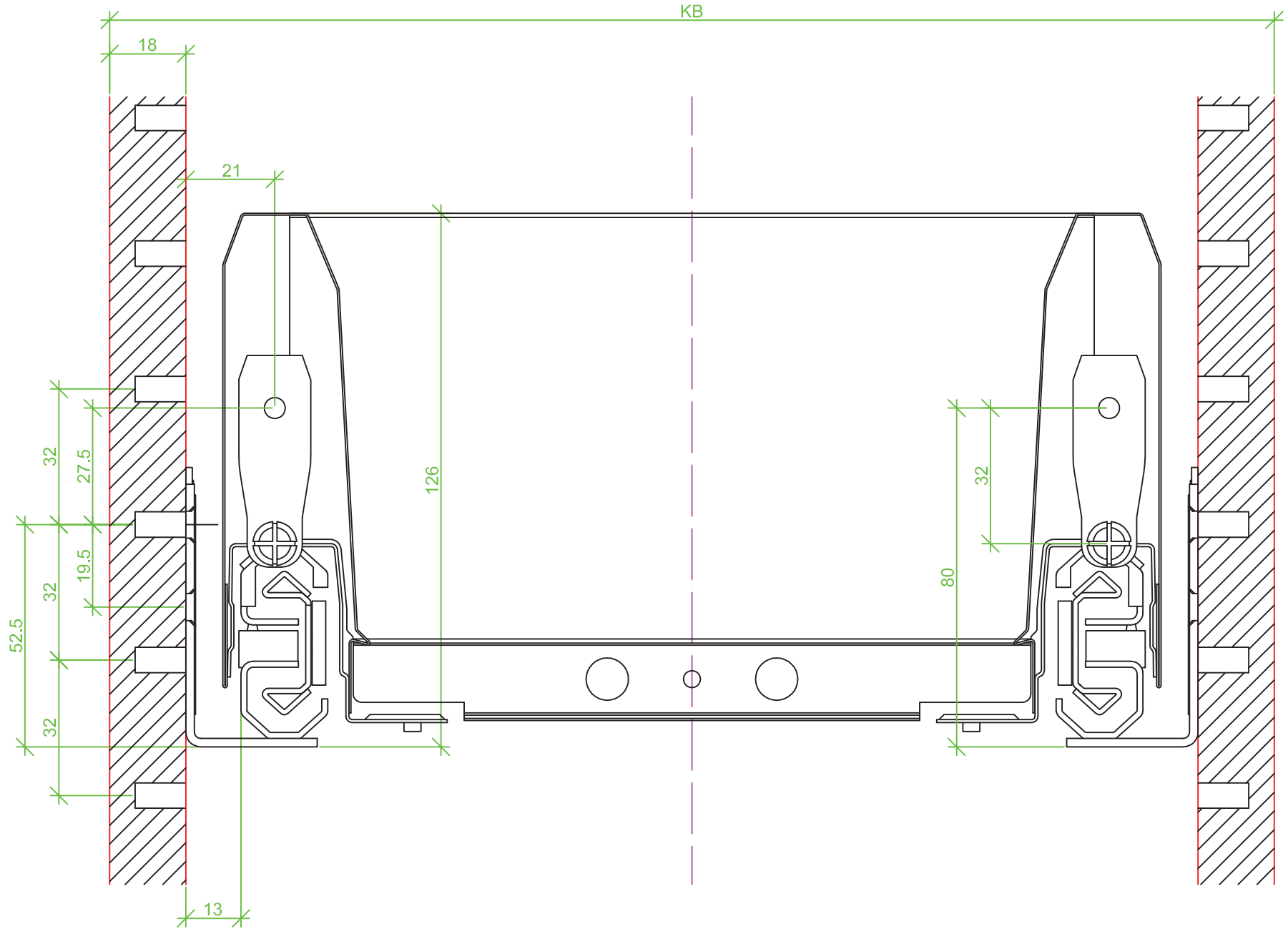

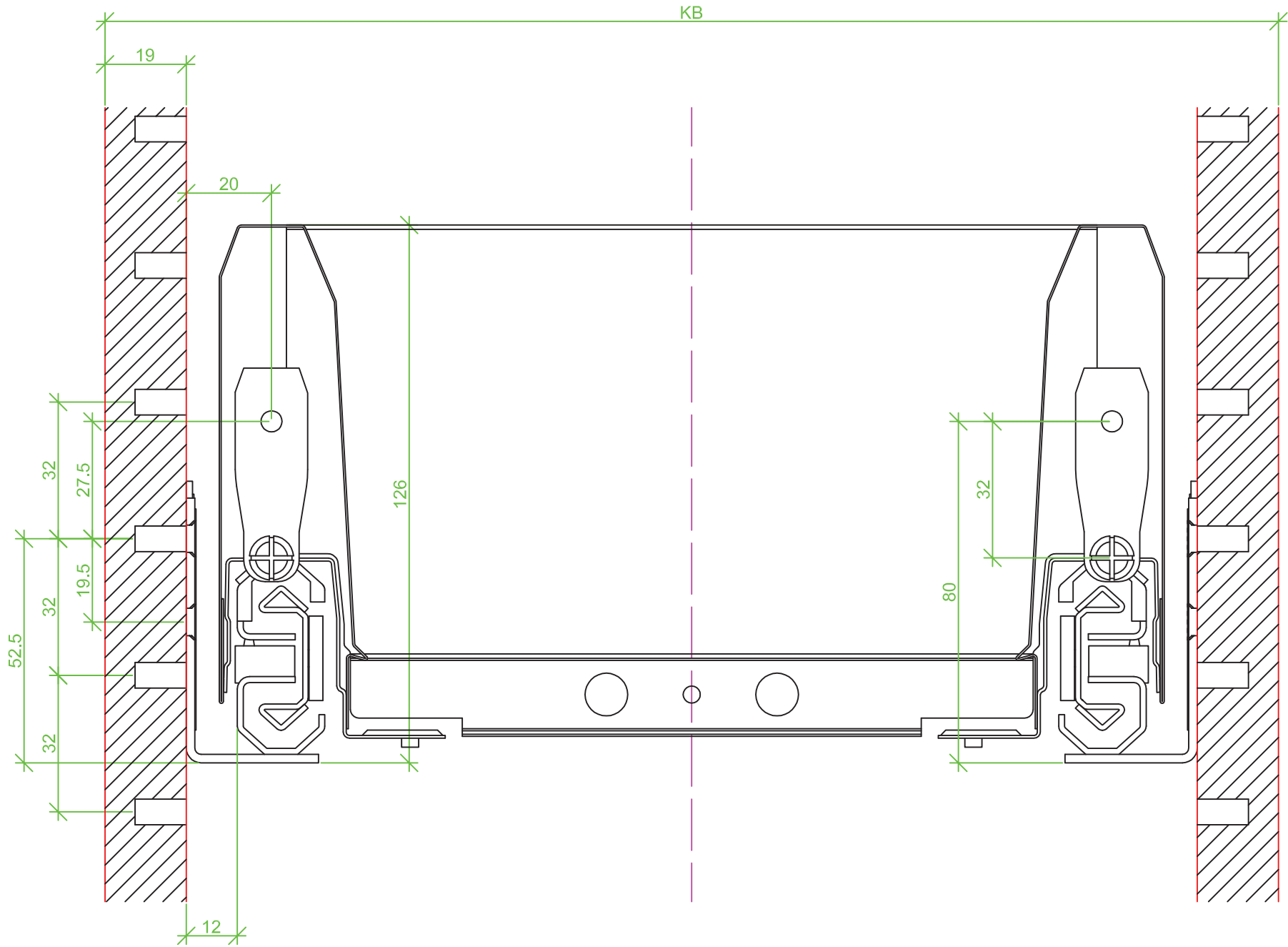

Sideview / Seitenansicht

