

Drawings / Zeichnungen:
AvanTech YOU

Technik für Möbel

Hettich

Model / Ausführung	Drawer / Schubkasten
Profile height / Zargenhöhe	101 mm
Cabinet side panel thickness / Korpuseitendicke	16 / 18 / 19 mm

Quadro YOU

Nominal length mm	Hole spacing b1 mm	Internal drawer / internal pot-and-pan drawer Minimum cabinet body depth mm
270	160	291
300	160	321
350	224	371
400	224	421
450	256	471
500	256	521
550	256	571
600	256	621

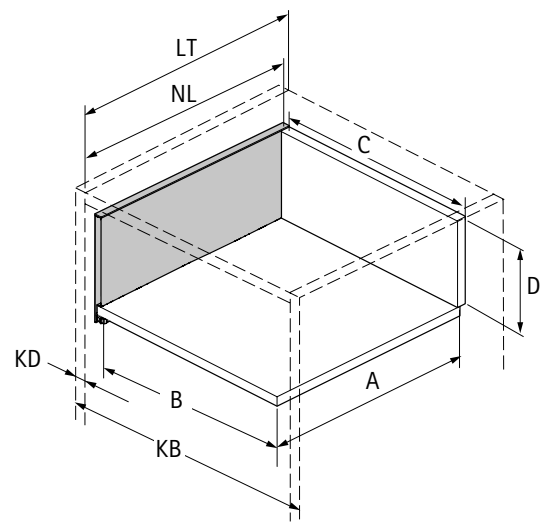

Actro YOU

Nominal length mm	Hole spacing b1 mm	Hole spacing b2 mm	Internal drawer / Internal pot-and-pan drawer Minimum cabinet body depth mm
270	160		282
300	160		312
350	224		362
400	224		412
450	256	288	462
500	256	320	512
550	256	320	562
600	256	320	612
650	256	416	662

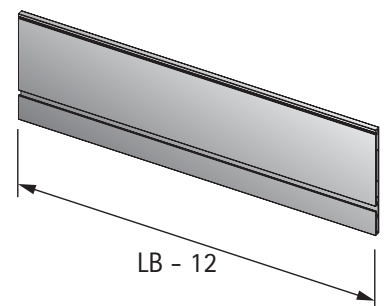

Measurement / Maß	Wooden rear panel / Holzrückwand
A	629
B	LB - 24
C	LB - 41
D	54

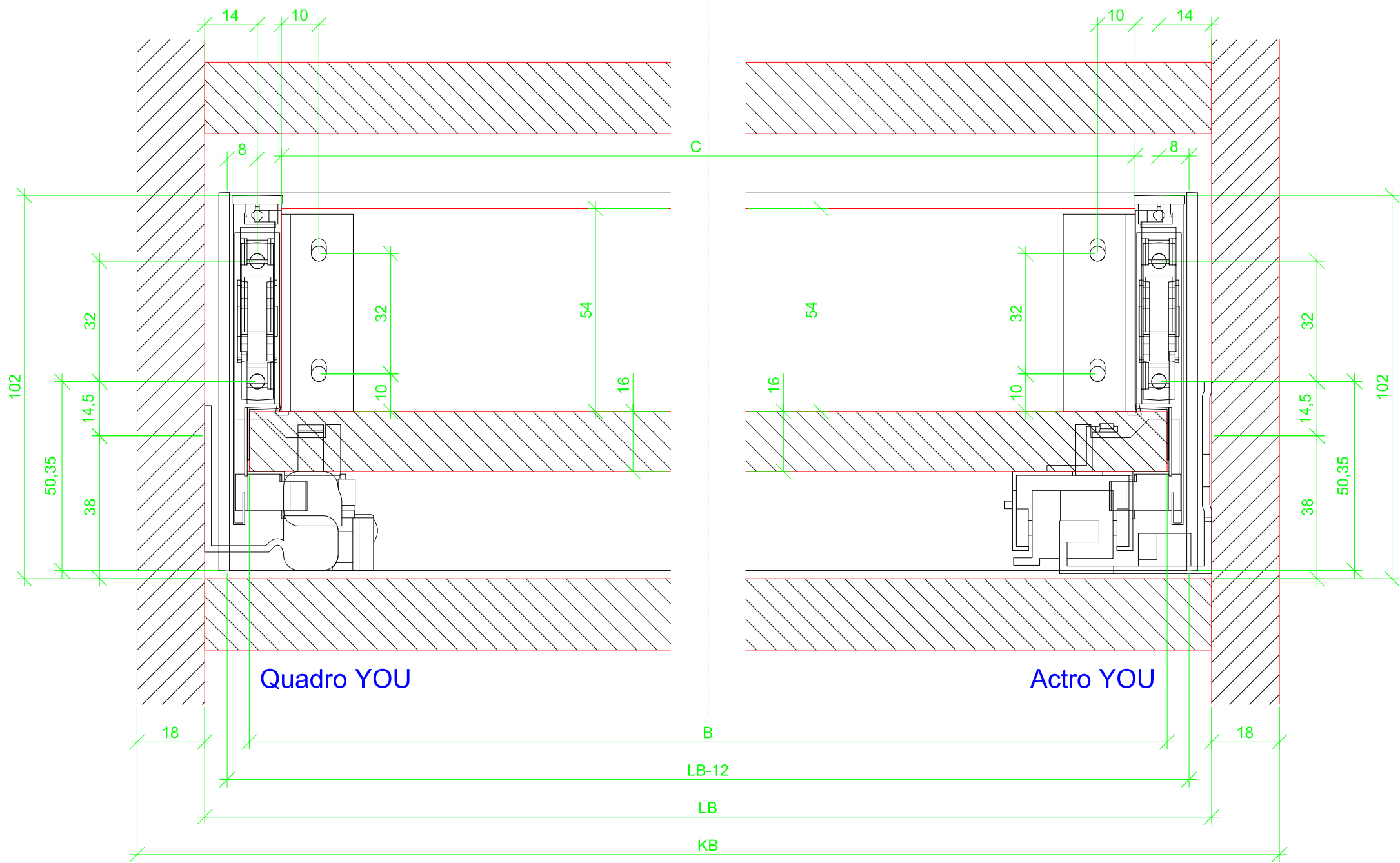

Frontview / Frontansicht 19 mm

